

x 2

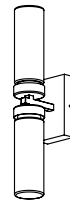

x 1/2

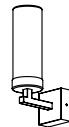

CELTIC

I 3346

II 3347

1

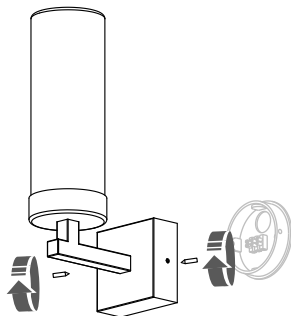

2

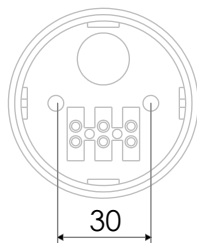

3

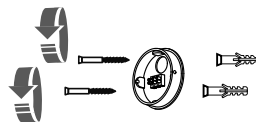

4

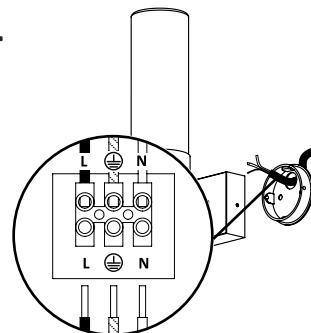

5

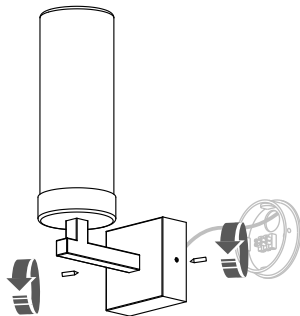

6

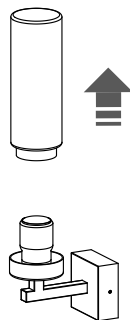

7

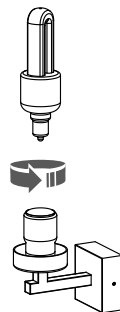

8

